

CSCD 330

Network Programming

Lecture 9

Transport Layer

Spring 2017

Reading: Begin Chapter 3

Some Material in these slides from J.F Kurose and K.W. Ross
All material copyright 1996-2007



Outline

- Overview of Transport Layer
- Multiplexing / Demultiplexing
- UDP
 - Functions
- Reliable Transport
- State Diagram of Reliable Transport
 - Building it from basics

Introduction Transport



- **Layers 1, 2 and 3**
 - Physical, Data Link and Network
 - Concerned with actual packaging, addressing, routing and delivery of data
 - Physical layer handles bits
 - Data link layer deals with local networks
 - Network layer handles routing between networks
- **Transport layer** in contrast, does not concern itself with these “nuts and bolts” matters
 - It relies on lower layers to handle process of moving data between devices

Transport Layer Purpose

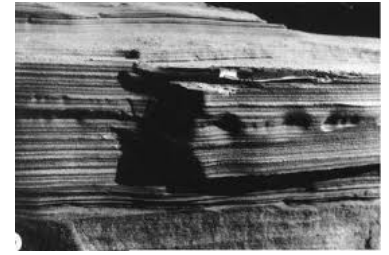

- **Transport layer's job**
- Provides for communication between application processes on different computers
 - Computers have many applications all trying to send and receive data
 - **Example:** Web Browser open
 - Bit Torrent downloading in the background and
 - WoW gaming session open
- Transport layer enables these applications to send and receive data
 - All applications must use same lower-layer protocol implementation

Transport Layer Purpose



- **How Does it Do This?**
- Transport layer protocol must keep track of data from each application,
 - Combines this data into a single flow of data to send to lower layers
 - Device receiving information must reverse these operations, splitting data and funneling it to appropriate recipient processes
- Transport layer provides connection services for protocols and applications that run at levels above it
- Categorized as either
 - Connection-oriented services
 - Connectionless services

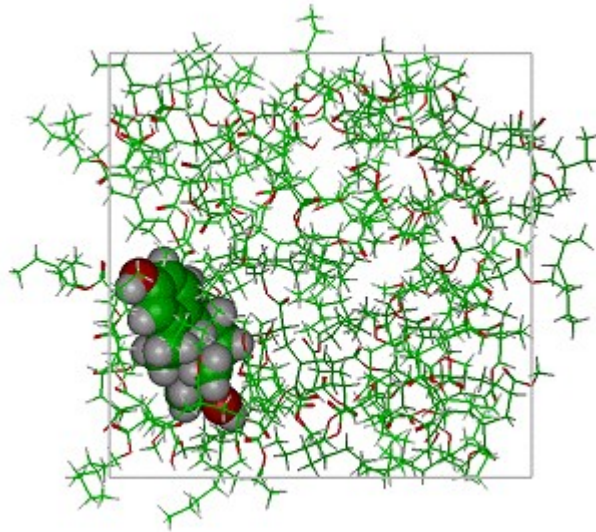

Transport Layer

Introduction to Transport Layer

- Recall the simplified model we have of today's Internet

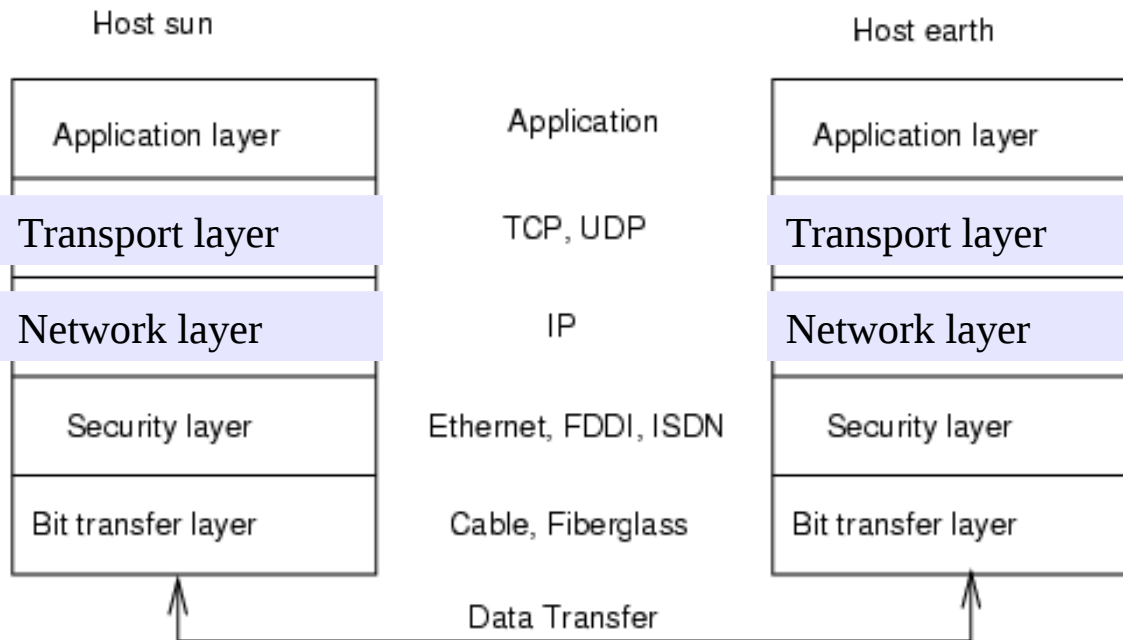

We are here

Introduction to Transport Layer

- What do we know about the Network Layer?
 - Best effort service
 - No guarantees
 - No orderly delivery of segments
 - Said to be “unreliable service”
 - All hosts have at least one IP address

Apps



Transport

Introduction to Transport Layer

- **On top of Network Layer**

- UDP and TCP two main protocols of transport layer

- **Responsibility of this layer**

- **Minimum**
- Extend delivery service between two hosts to
- Delivery service between two processes running on a source and destination host
- Error checking of packets

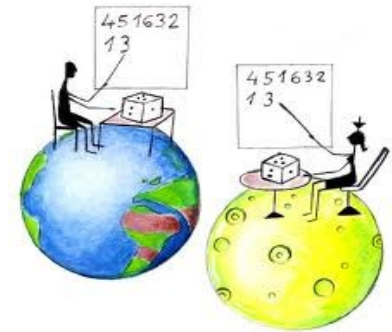

Transport Layer UDP

- Two flavors of Transport Protocols
- UDP – simpler, faster and unreliable
 - What does it do?

- Delivers packets →



- Checks Errors →



That's all it does!

Transport Layer TCP

- TCP – more complex, slower and reliable

- What does it do?

- Flow control



- Sequence numbers for packets

1,2,3,4,5,6,7 ... 10

- Acknowledgments and timers



- Ensures data arrives in order and is correct

- Congestion control



Introduction Transport Layer

Goals

- Understand principles behind transport layer services
 - Multiplexing/demultiplexing
 - Reliable data transfer vs Unreliable data transfer
 - Flow control
 - Congestion control

Transport services and protocols

- Provide **Logical Communication** between application processes running on different hosts
- Transport protocols run on end systems
 - **Sender side**
Breaks messages into **segments**, pass to network layer
 - **Receiver side**
Reassembles segments into messages, pass to application layer

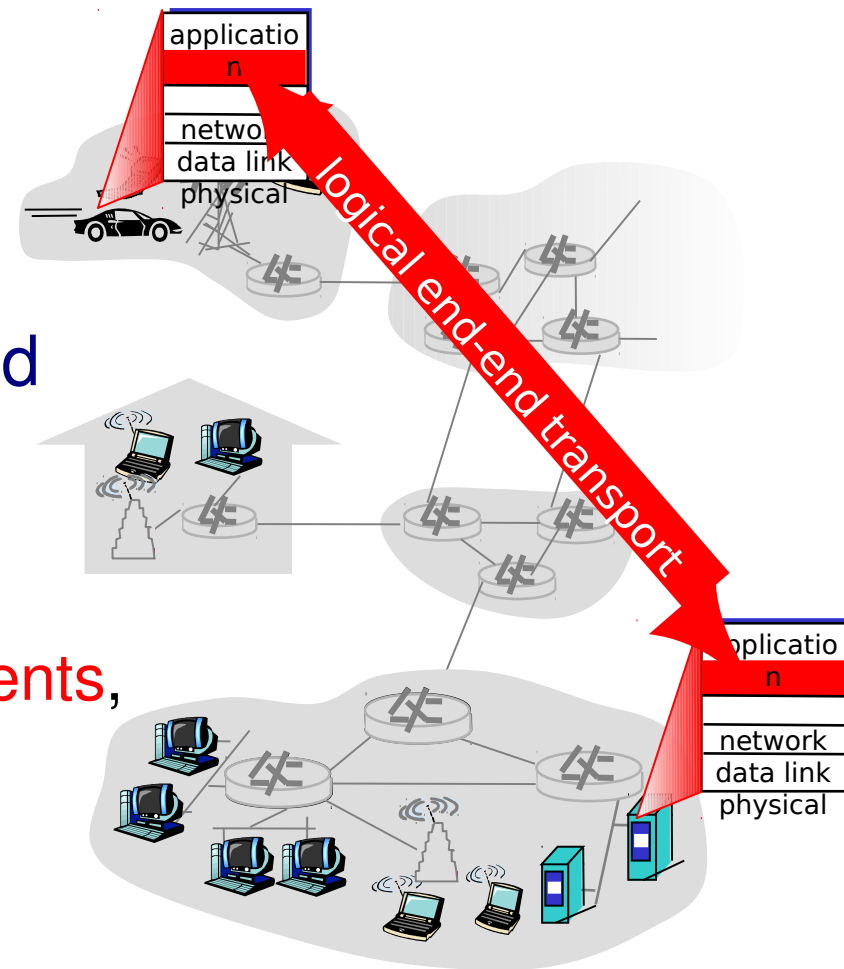

Transport vs. Network Layer

- Network layer
- Logical communication between **hosts**

- Transport layer
- Logical communication between **processes**
 - Relies on and enhances, network layer services

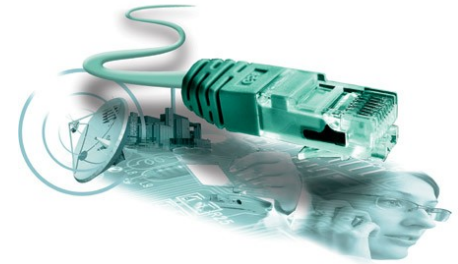

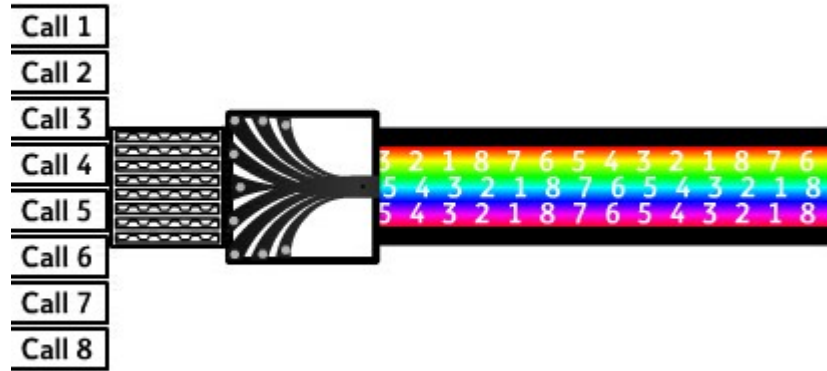

Multiplexing and demultiplexing In General

Multiplexing and Demultiplexing

- Transport protocol does multiplexing and demultiplexing
 - Sends and Delivers packets to correct application
 - Say single host runs four network applications
 - FTP session,
 - 2 SSH Sessions,
 - HTTP Session
 - TCP Layer must keep track of four applications and their separate streams of data

Multiplexing and Demultiplexing

- Transport protocol does multiplexing and demultiplexing
 - Gathers data from different applications,
 - Through sockets,
 - Encapsulates each data chunk with headers and passes them to network layer
 - > Multiplexing
 - Delivers data to receiving socket of application
 - > Demultiplexing
 - Recall Sockets? How do sockets help with this?



Multiplexing/demultiplexing

Demultiplexing at rcv host:

Delivering received segments to correct socket

Multiplexing at send host:

Gathering data from multiple sockets, enveloping data with header (later used for demultiplexing)

■ = socket ○ = process

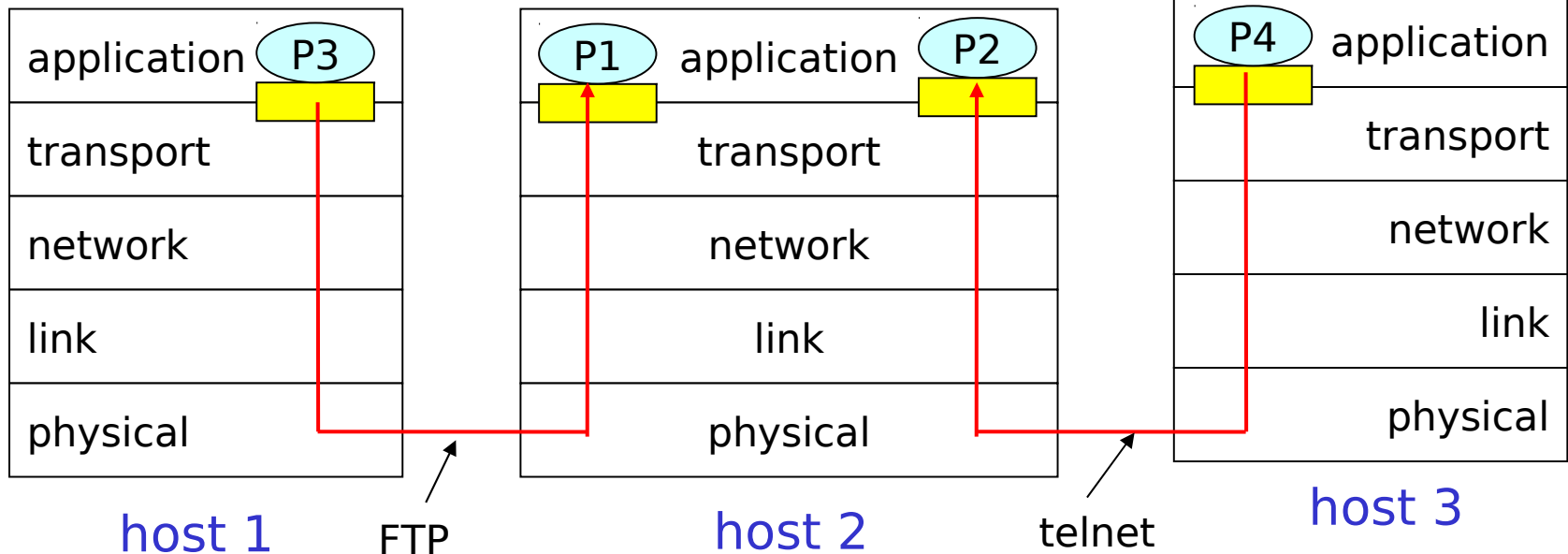

How Demultiplexing Works

Host Receives IP Datagrams

- Each Datagram has source IP Address, Destination IP Address
- Each Datagram carries 1 transport layer segment
- Each Segment has source/destination port number

Host Uses IP Addresses and Port numbers ----> direct segments to appropriate socket

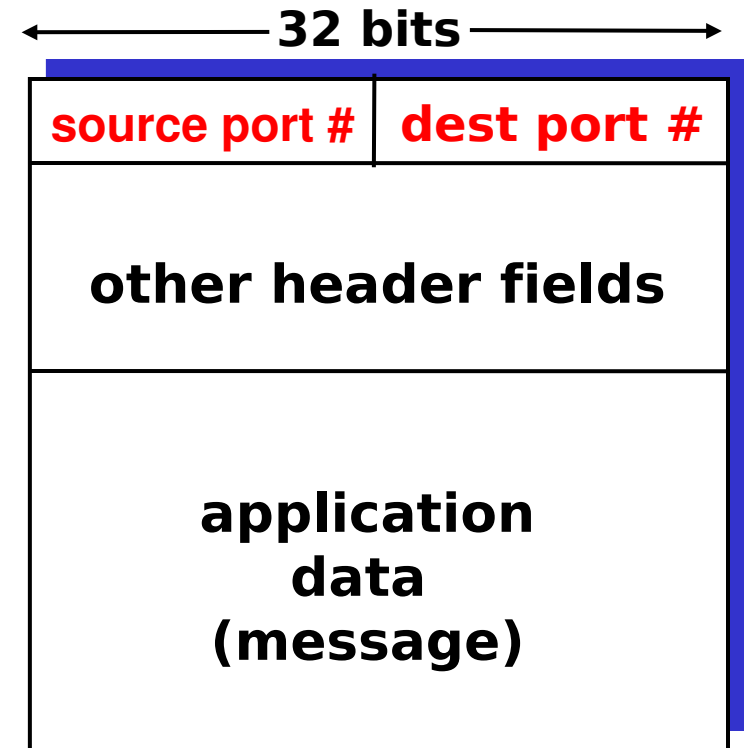

**Generic
TCP/UDP segment format**



UDP Demultiplexing

Connectionless UDP Demultiplexing

- Sockets have port numbers
 - DatagramSocket mySocket1 = new DatagramSocket(12534);**
 - DatagramSocket mySocket2 = new DatagramSocket(12535);**
- Note: Above are examples of UDP Servers
- UDP Socket identified by two-tuple:
(dest IP address, dest port number)
- When host receives UDP segment
 - Checks destination port number within data
 - Directs UDP segment to socket with that port number

Connectionless UDP Demultiplexing

DatagramSocket serverSocket = new DatagramSocket(**6428**);

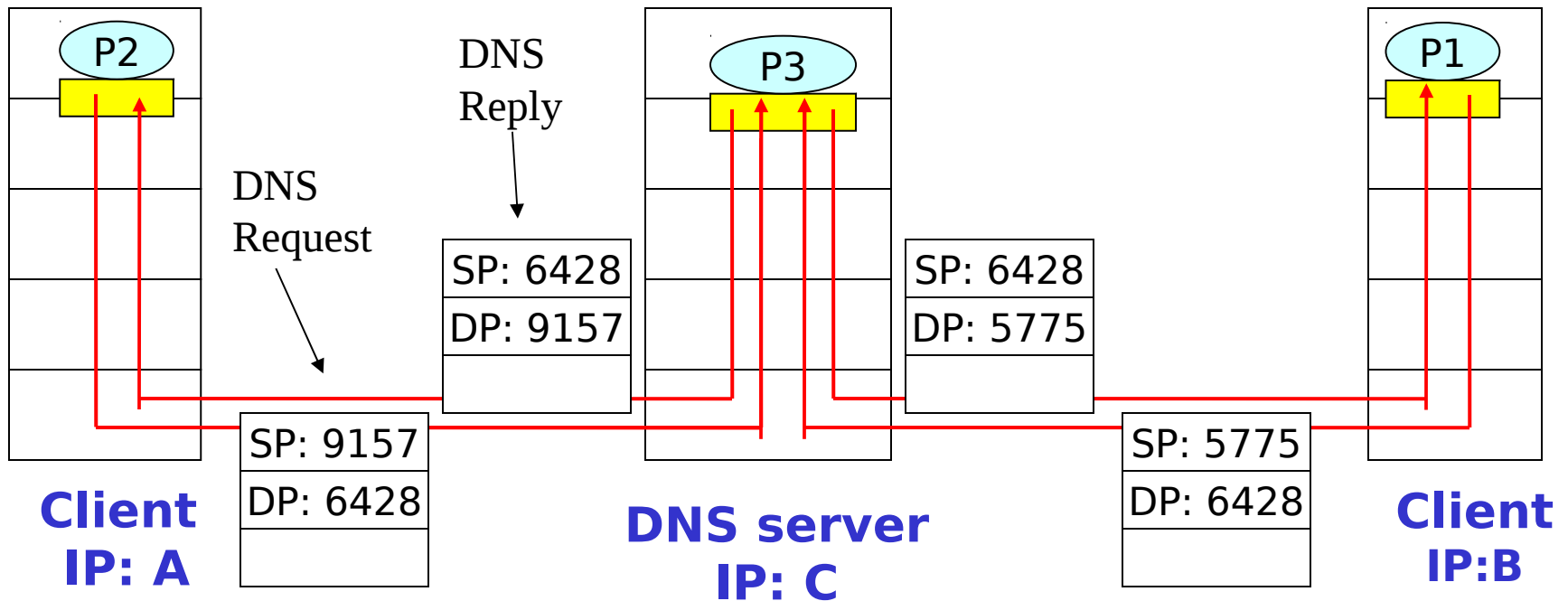

Dest Port (DP) provides "send address"
Src Port (SP) provides "return address"



TCP Demultiplexing

Connection-oriented TCP Demultiplexing

- TCP socket identified by 4-tuple:
 - Source IP address
 - Source port number
 - Dest IP address
 - Dest port number
- Receive host uses all four values to direct segment to appropriate socket
- Server may support many simultaneous TCP sockets:
 - Each socket identified by its own 4-tuple
- Web servers **can** have multiple different connections for each connecting client
 - **Why is that?**
 - Non-persistent HTTP will have different socket for each request!!!

Connection-oriented TCP Demultiplexing

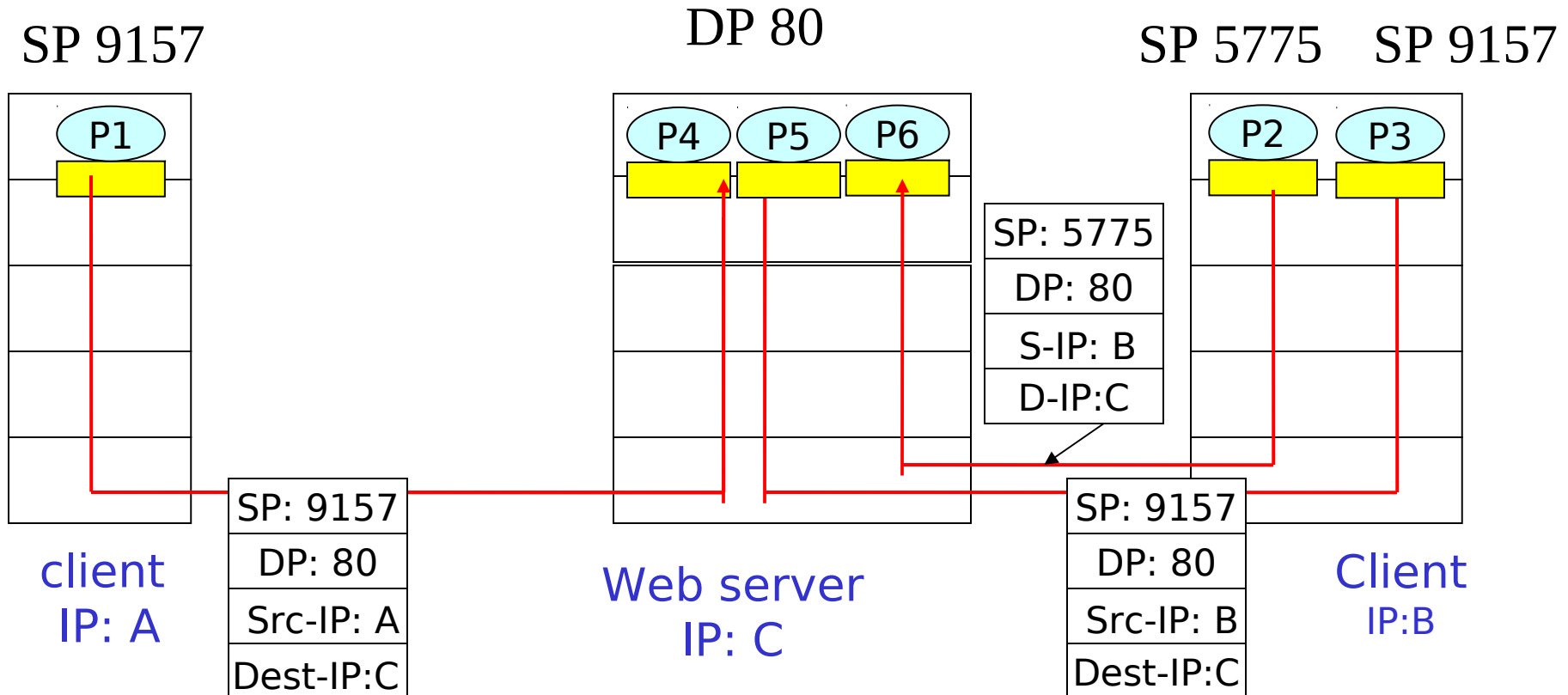

Note: Two machines with same
Source Port (SP) = 9157,
Is that allowed?

Connection-oriented demultiplexing Threaded Web Server

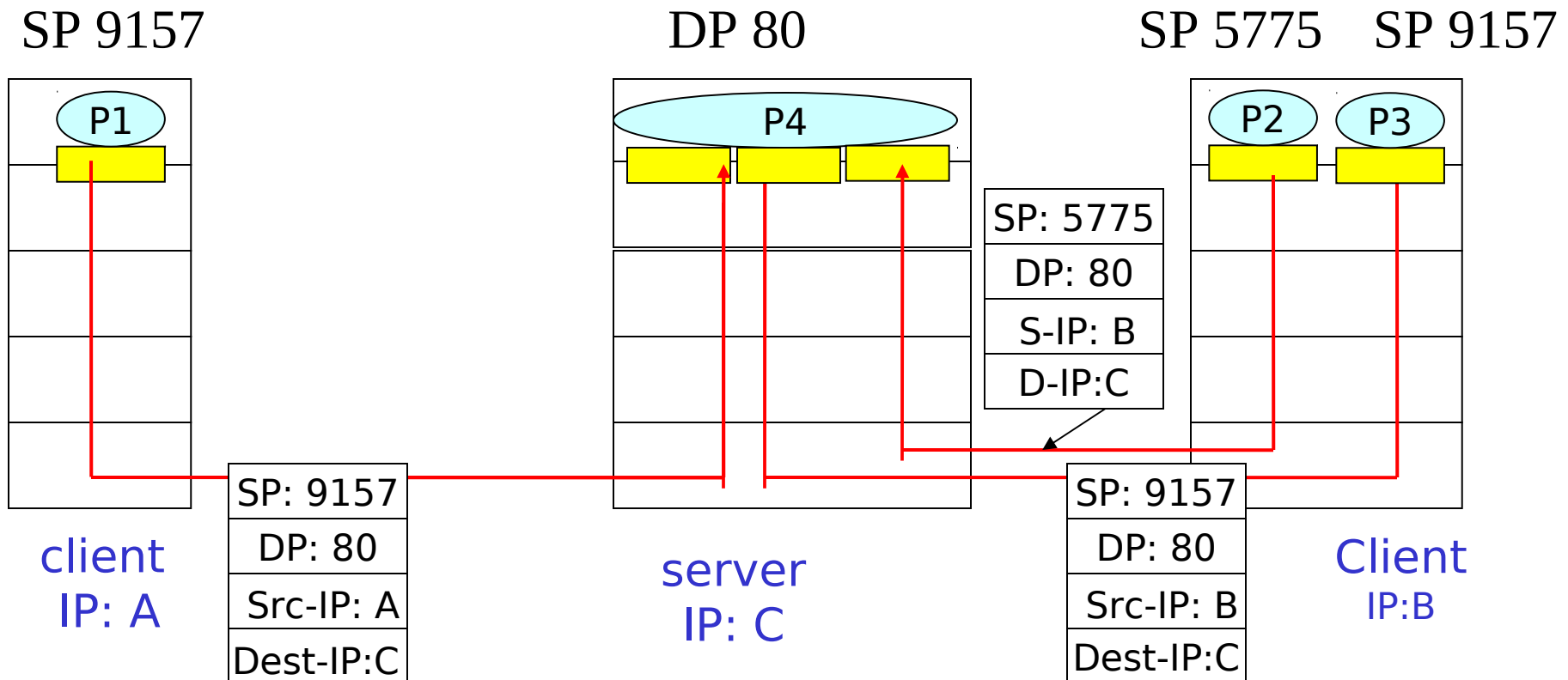

UDP: More

- Often used for streaming multimedia applications
 - Loss tolerant
 - Faster
- Other UDP uses
 - DNS
 - SNMP
- **Reliable transfer over UDP**
- **How would you do it?**
- Add reliability at application layer
 - Application-specific error recovery!

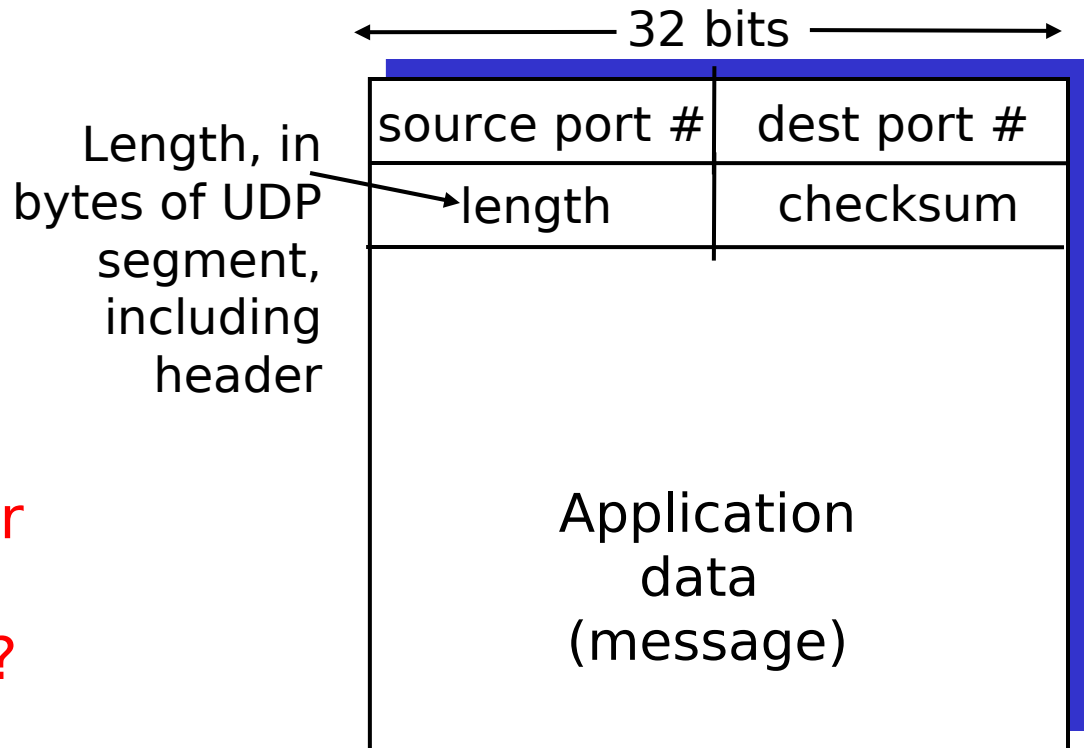

UDP segment format

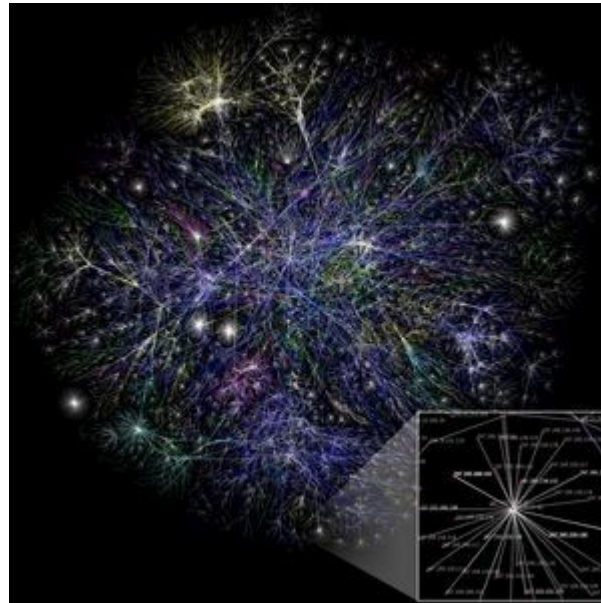

Connection Oriented Transport

Transport Reliability

- What does it mean to be reliable if you are a transport protocol?
 - No data is corrupted
 - All data is delivered in order in which it was sent
 - All data is delivered, not lost
 - Delivered when needed, time aspect important

Reliable Data Transfer

- **Next few slides,**
 - Build a reliable transfer protocol step by step
 - So, you can see the design decisions that went into the design of TCP to make it reliable
 - Have a protocol that works perfectly to deliver data reliably ...

Reliable data Transfer

We'll

- Incrementally develop sender, receiver sides of reliable data transfer protocol (**rdt**)
- Consider only unidirectional data transfer
 - But control info will flow in both directions!
- Use Finite State Machines (FSM) to specify sender, receiver

State: When in this "state" next state uniquely determined by next event

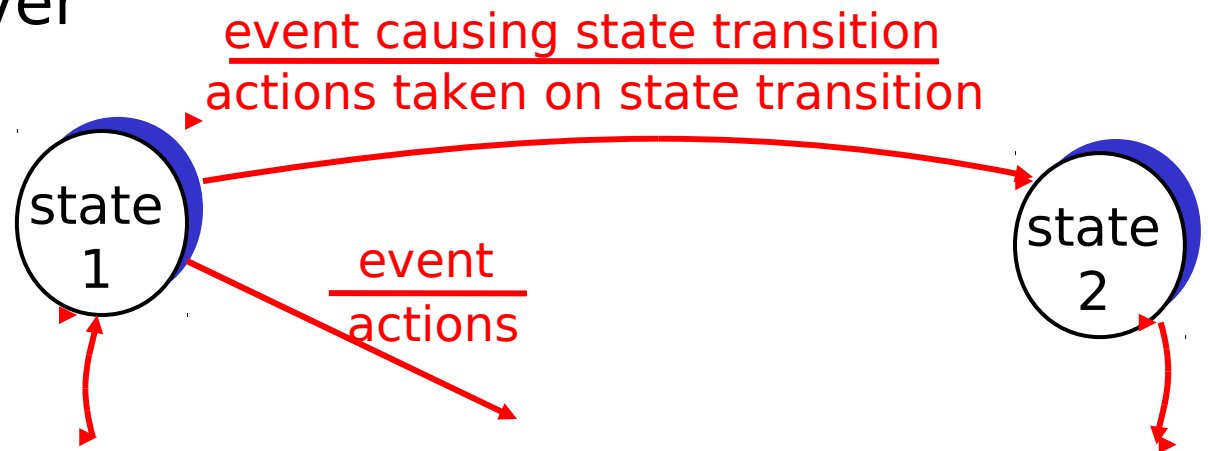

Rdt1.0: Reliable transfer over reliable channel

- **Underlying channel perfectly reliable**
 - No bit errors
 - No loss of packets
- **Separate FSMs for Sender, Receiver**
 - Sender sends data into underlying channel
 - Receiver reads data from underlying channel

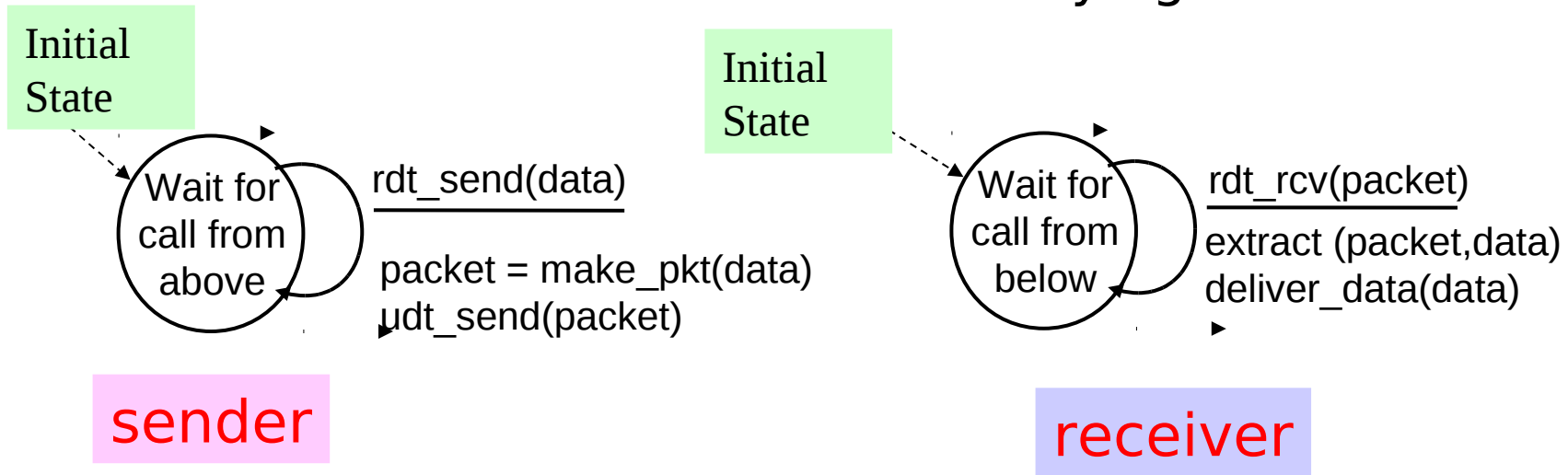

Rdt2.0: Channel With Bit Errors

- What do we need to add to protocol to deliver packets with Bit Errors?

Rdt2.0: Channel With Bit Errors

- What do we need to add to protocol to deliver packets with Bit Errors?
 - Method to detect errors
 - Method to send back a negative acknowledgment
 - Recognition of negative ack -> resend of packet

Rdt2.0: Channel with bit errors

- Underlying channel may flip bits in packet
 - Checksum to detect bit errors
- How to recover from errors?
 - **Acknowledgments (ACKs)**: Receiver tells sender that packet received OK
 - **Negative acknowledgments (NAKs)**: Receiver tells sender that packet had errors
 - Sender retransmits packet on receipt of NAK
- New mechanisms in **rdt2.0** (beyond **rdt1.0**):
 - Error detection
 - Receiver feedback: control msgs (ACK,NAK)
rcvr->sender

Rdt2.0: FSM specification

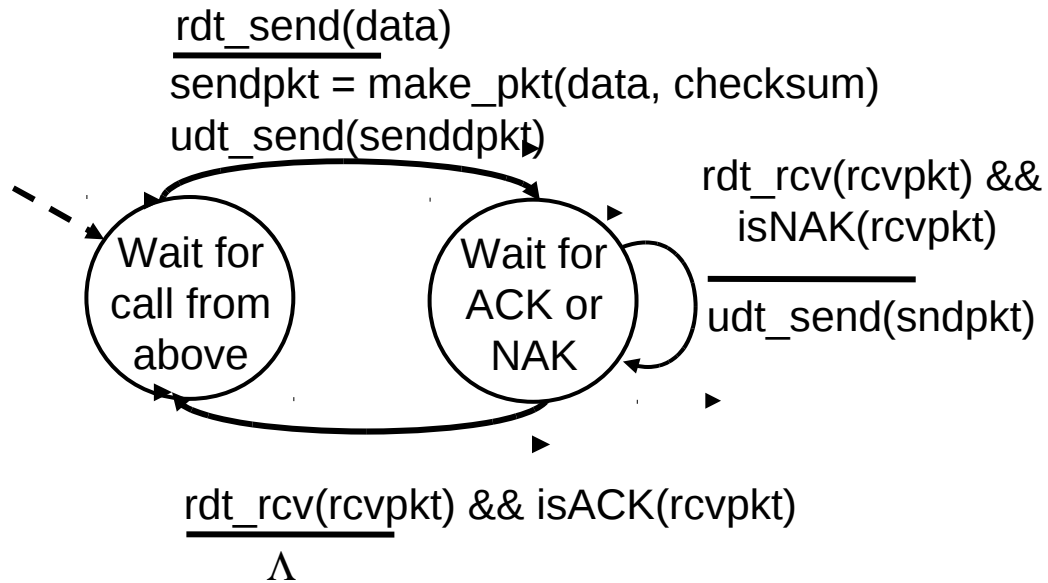

sender

Λ - Means no action on event

receiver

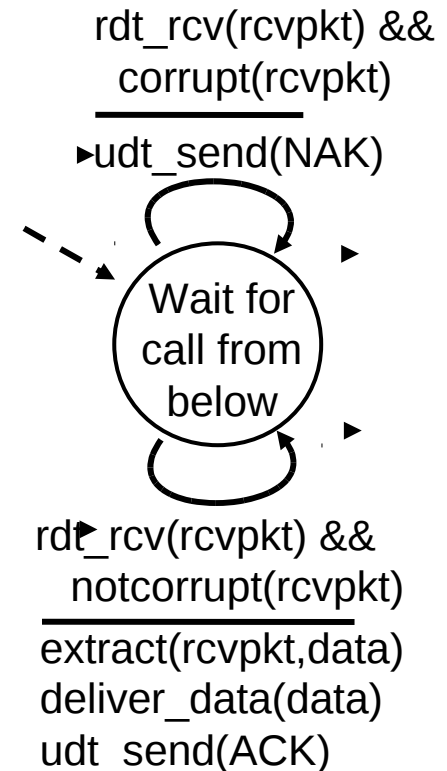

Rdt2.0: operation with no errors

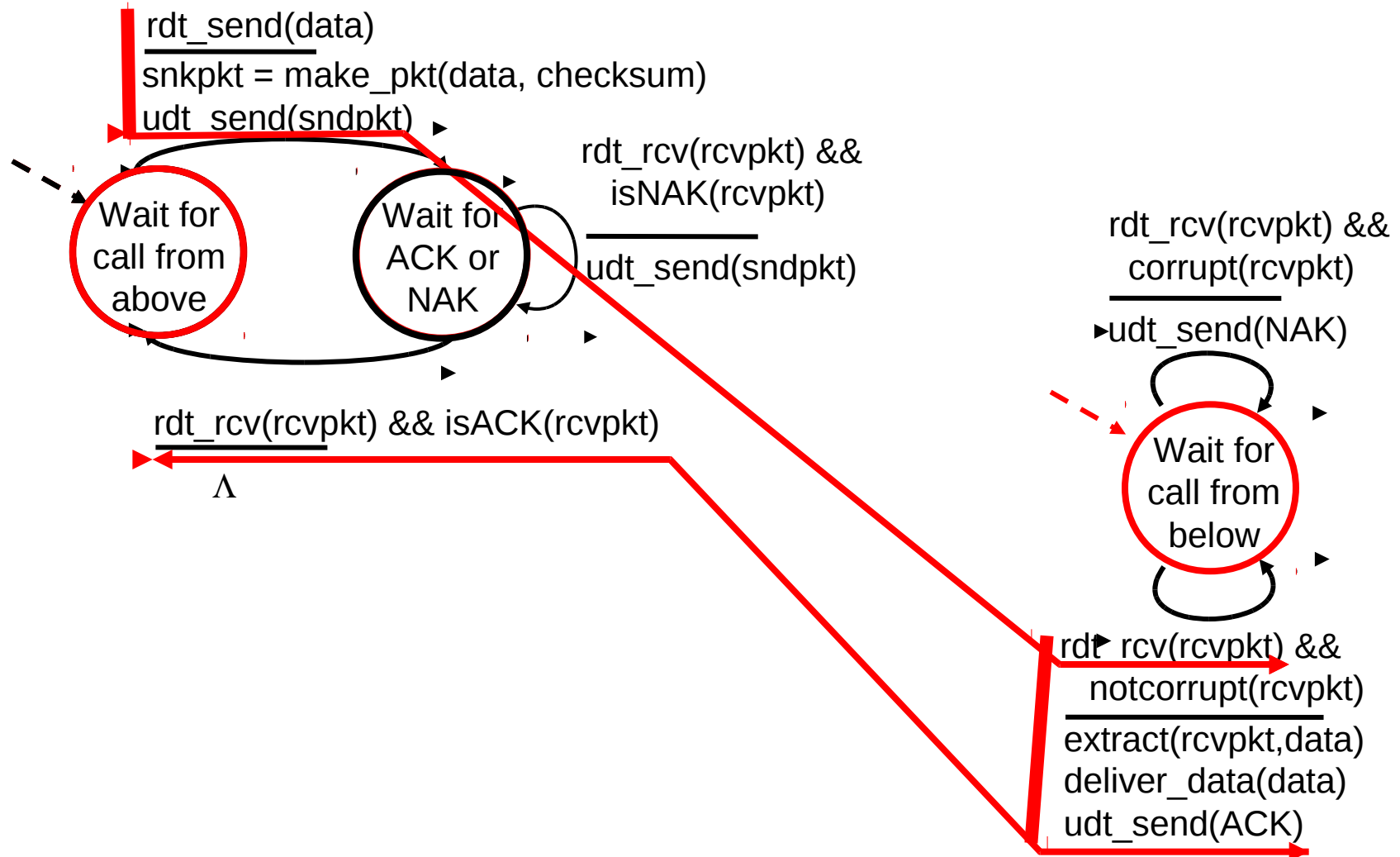

Rdt2.0: error scenario

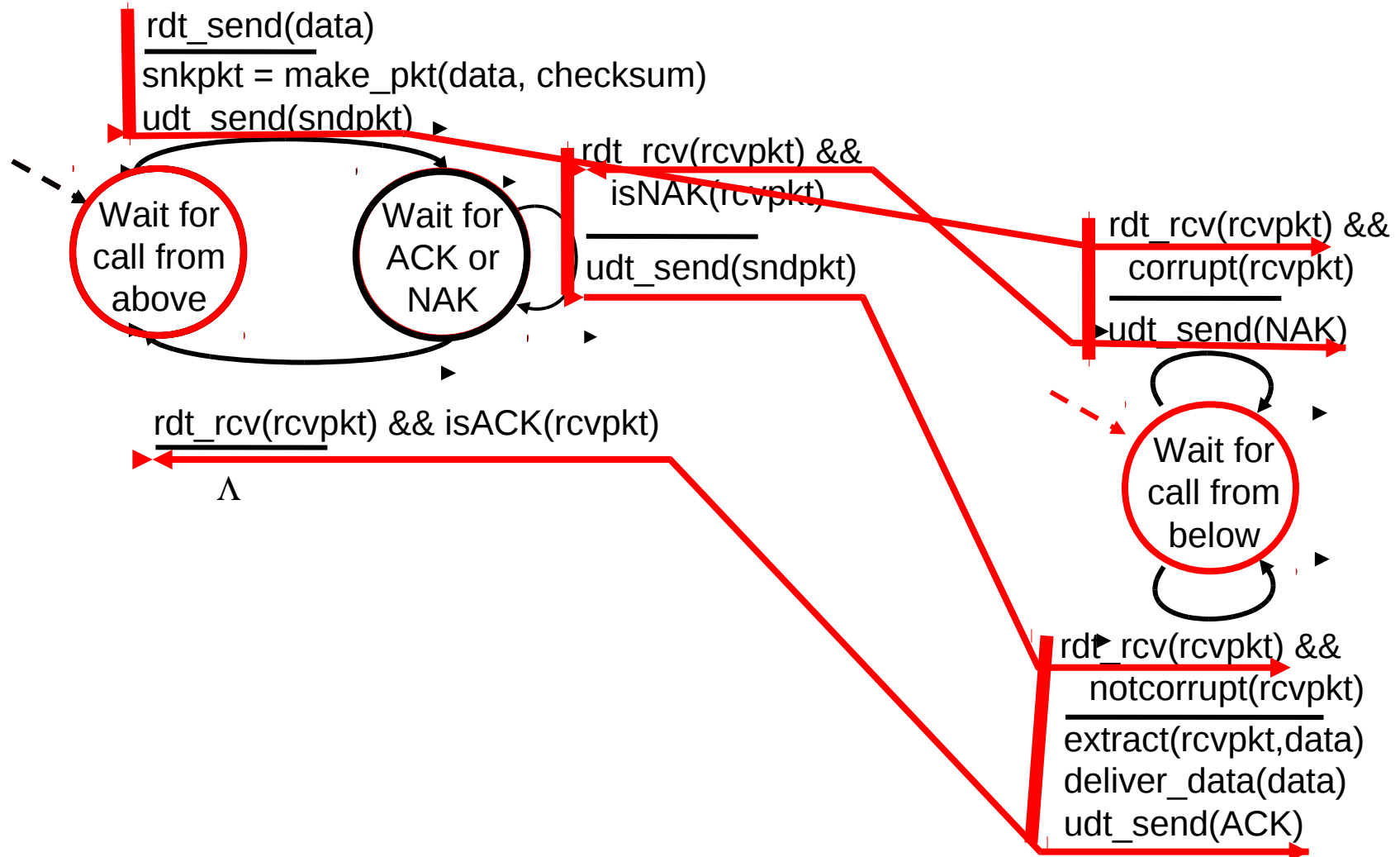

Rdt2.0 Has a fatal flaw!

Repeat
that

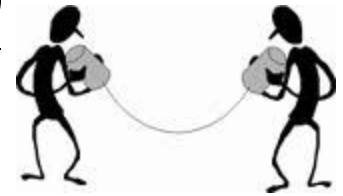

What happens if ACK/NAK corrupted?

- Sender doesn't know what happened at receiver!
- If Human conversation, just say, please repeat that ... maybe multiple times
- If Computer conversation
 - Add enough checksum bits to correct the error
 - Or, retransmit, but add identifier to packet to say its a retransmission ... this is what TCP does!!!

Rdt2.0 Has a fatal flaw!

Handling Duplicates:

- Sender retransmits current packet if ACK/NAK garbled
- Sender adds **sequence number** to each packet
- Receiver discards (doesn't deliver up) duplicate packet

stop and wait

Sender sends one packet,
then waits for receiver
response

Rdt2.1: Sender, handles garbled ACK/NAKs

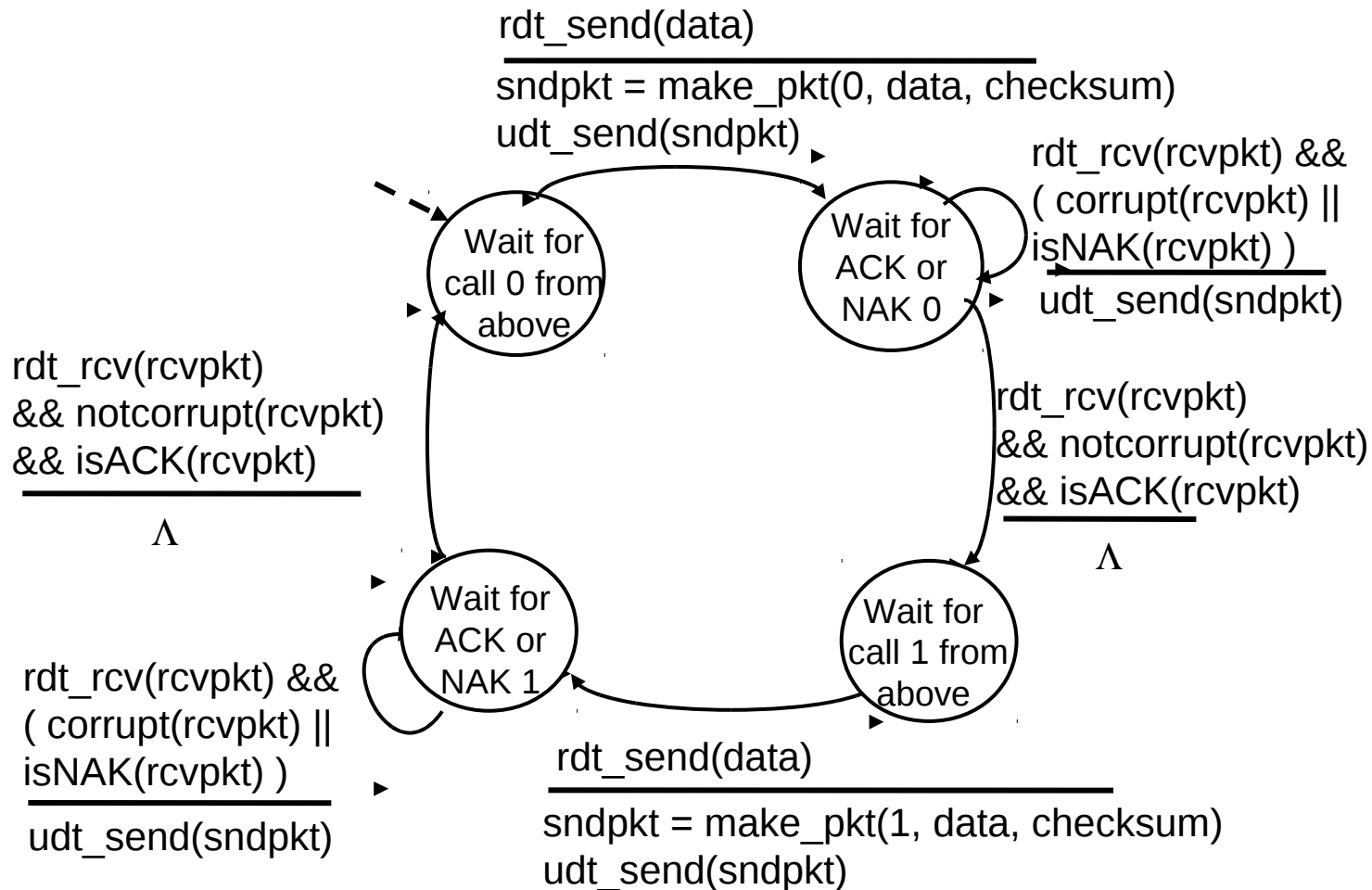

Rdt2.1: receiver, handles garbled ACK/NAKs

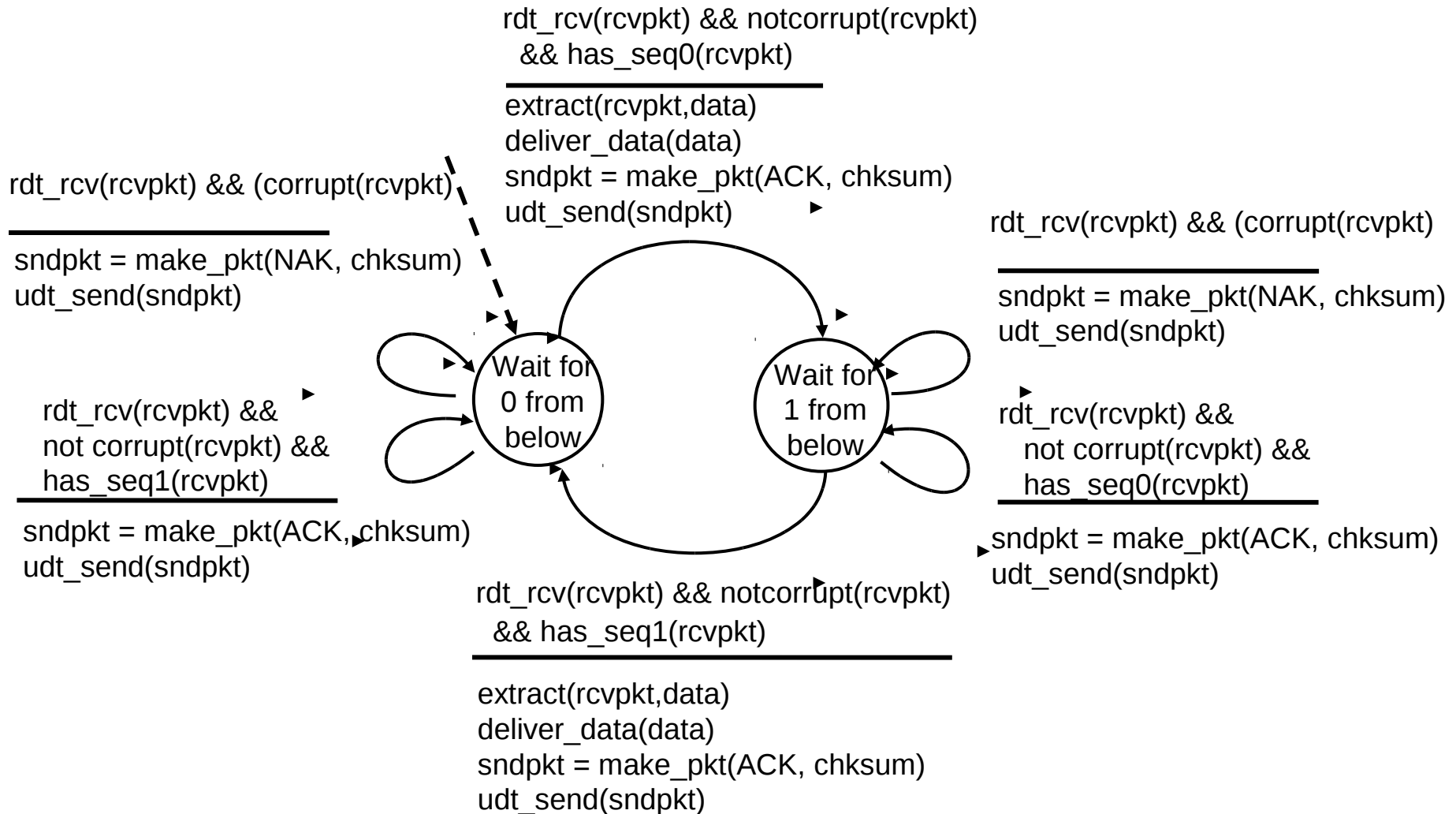

Rdt2.1: Discussion

Sender

- Seq number added
- Two sequence numbers (0,1). Is that enough?
- Must check if received ACK/NAK corrupted
- Twice as many states
 - State must “remember” whether “current” packet has 0 or 1 sequence number

Receiver

- Must check if received packet is duplicate
 - State indicates whether 0 or 1 is expected packet sequence number
- Note: receiver can *not* know if its last ACK/NAK received OK at sender

Rdt2.2: Improves upon Rdt 2.1

NAK-free protocol



- Same functionality as Rdt2.1, using ACKs only instead of NAK
- Receiver sends ACK for last packet received OK
 - Receiver must explicitly include seq number of packet being ACKed
- Duplicate ACK at sender results in same action as NAK
- **Retransmit current packet!!**

Rdt3.0: Now Have Channels with Errors and Loss

New Assumption

- Underlying channel can also lose packets (data or ACKs)
- Sender doesn't know if data packet or ACK was lost, or just delayed
 - So far
 - Checksums, Sequence numbers,
 - ACKs, Retransmissions
- Are these enough to account for lost packets?

Rdt3.0: Now Have Channels with Errors *and* Loss

Approach: Sender waits “reasonable” amount of time for ACK

- Retransmits if no ACK received in this time
- If packet (or ACK) just delayed (not lost):
 - Retransmission will be duplicate, but use of sequence #'s already handles this
 - Receiver must specify seq # of packet being ACKed
- Requires countdown timer

rdt3.0 sender

Gets more complicated with timer

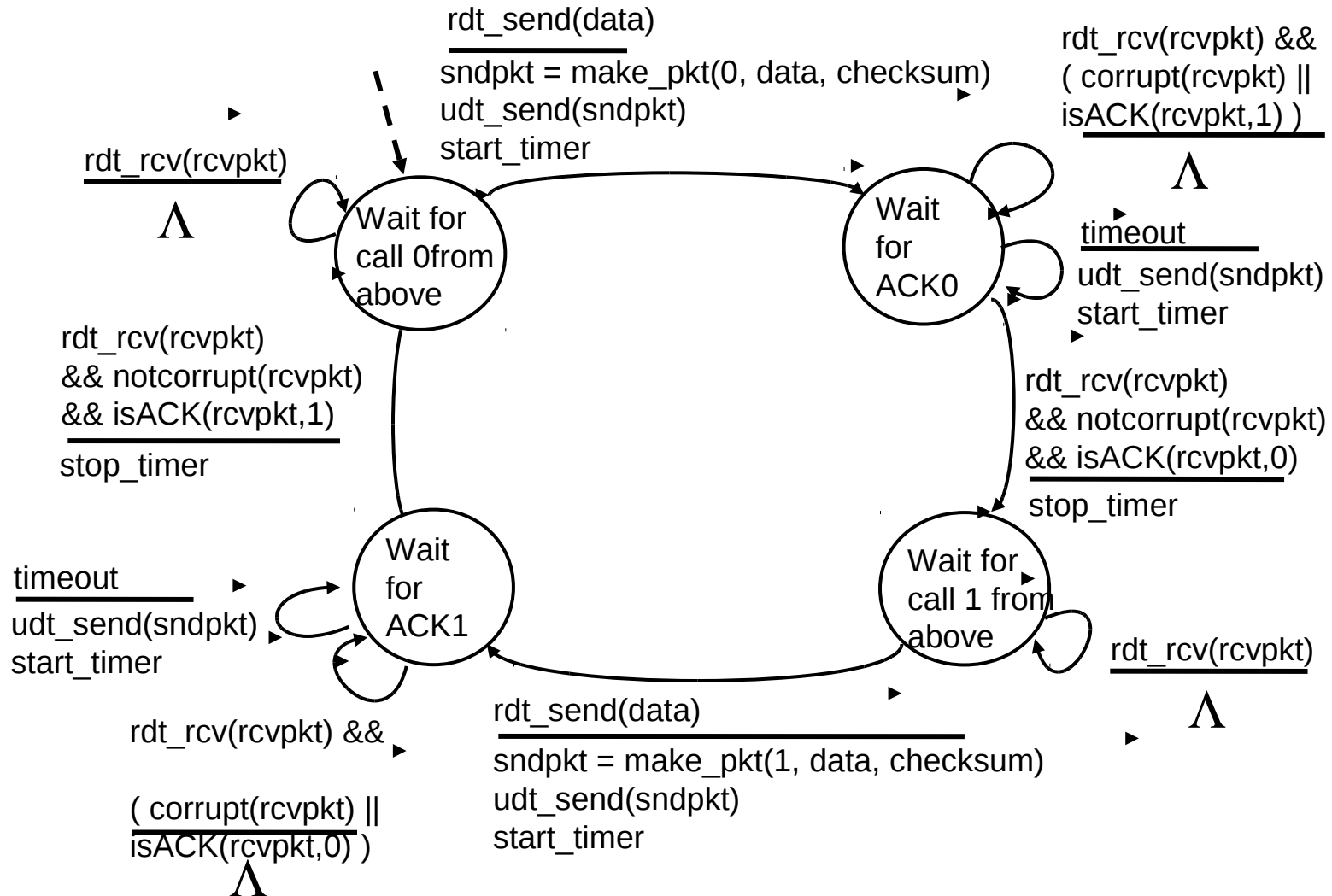

Summary

- Described what the transport layer does
- Introduced general concepts of a connection-oriented, transport protocol
- Making something reliable is not easy!!
 - Complex, not easy to understand
 - Discussed how you would build in reliability
- Moving on to examine TCP as an example of a reliable protocol

References

- RFC of TCP v4, 1981

<http://www.ietf.org/rfc/rfc0793.txt>

- Original Paper by Authors of TCP/IP Suite

Vinton G. Cerf, Robert E. Kahn, A Protocol for Packet Network Intercommunication, IEEE Transactions on Communications, Vol. 22, No. 5, May 1974 pp. 637-648

<http://penguin.ewu.edu/cscd330/cerf74-2.pdf>

TCP Packet Format

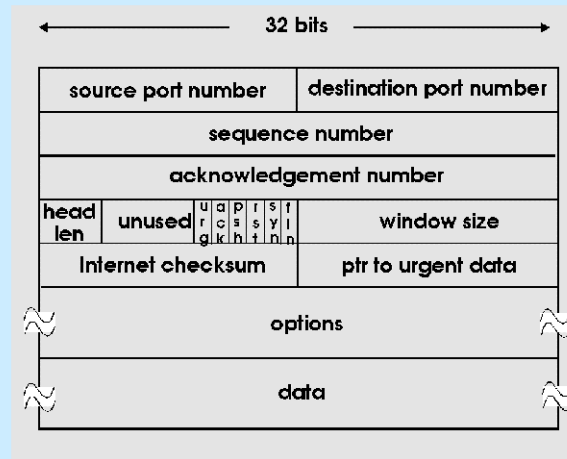

Transport Protocol

Read: Keep reading Chapter 3 - Transport

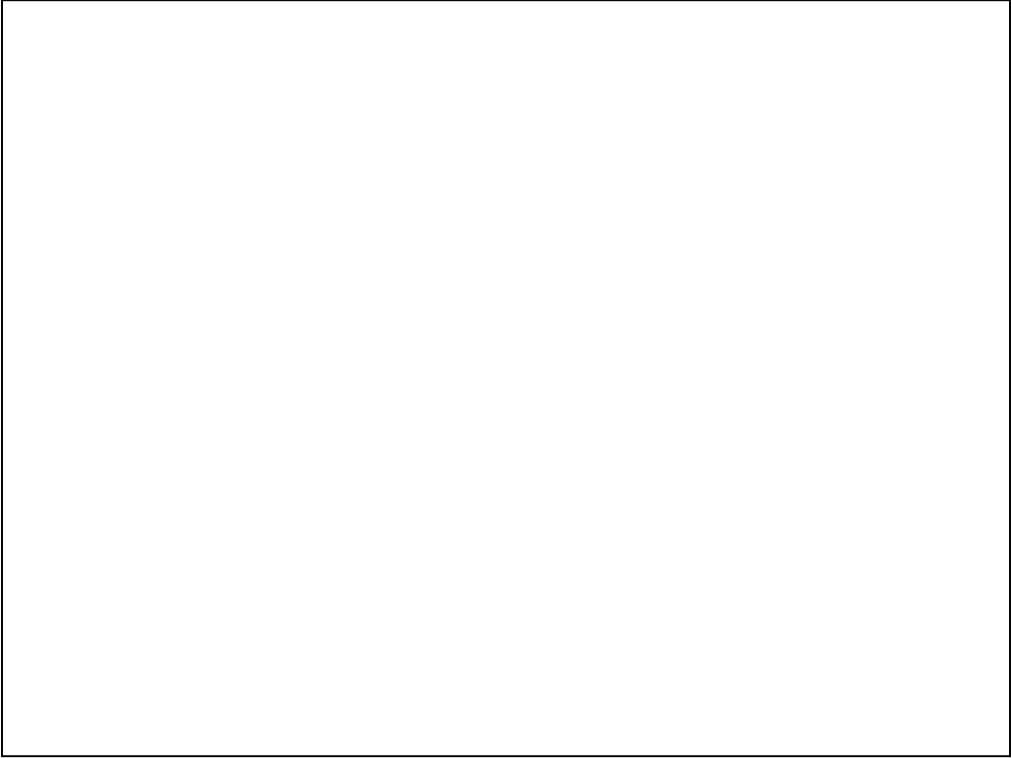

Outline

- Overview of Transport Layer
- Multiplexing / Demultiplexing
- UDP
 - Functions
- Reliable Transport
- State Diagram of Reliable Transport
 - Building it from basics

Introduction Transport



- **Layers 1, 2 and 3**
 - Physical, Data Link and Network
 - Concerned with actual packaging, addressing, routing and delivery of data
 - Physical layer handles bits
 - Data link layer deals with local networks
 - Network layer handles routing between networks
- **Transport layer** in contrast, does not concern itself with these “nuts and bolts” matters
 - It relies on lower layers to handle process of moving data between devices

Transport Layer Purpose

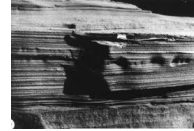

- **Transport layer's job**
- Provides for communication between application processes on different computers
 - Computers have many applications all trying to send and receive data
 - **Example:** Web Browser open
Bit Torrent downloading in the background and
WoW gaming session open
- Transport layer enables these applications to send and receive data
 - All applications must use same lower-layer protocol implementation

Transport Layer Purpose



- **How Does it Do This?**
- Transport layer protocol must keep track of data from each application,
 - Combines this data into a single flow of data to send to lower layers
 - Device receiving information must reverse these operations, splitting data and funneling it to appropriate recipient processes
- Transport layer provides connection services for protocols and applications that run at levels above it
- Categorized as either
 - Connection-oriented services
 - Connectionless services







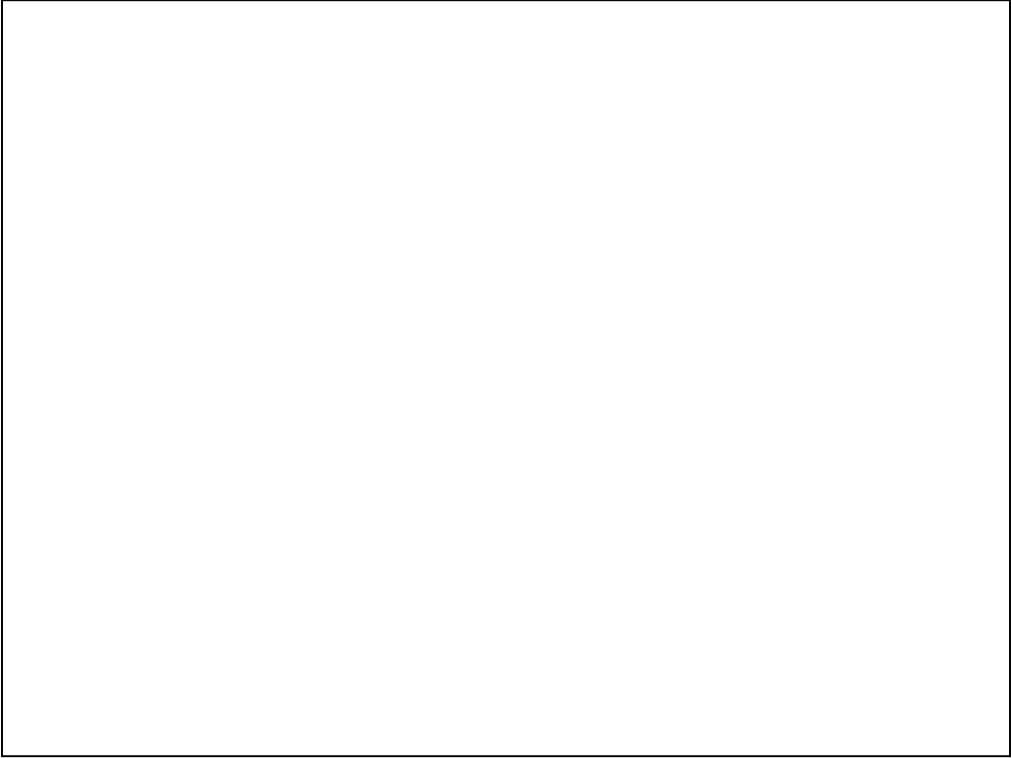

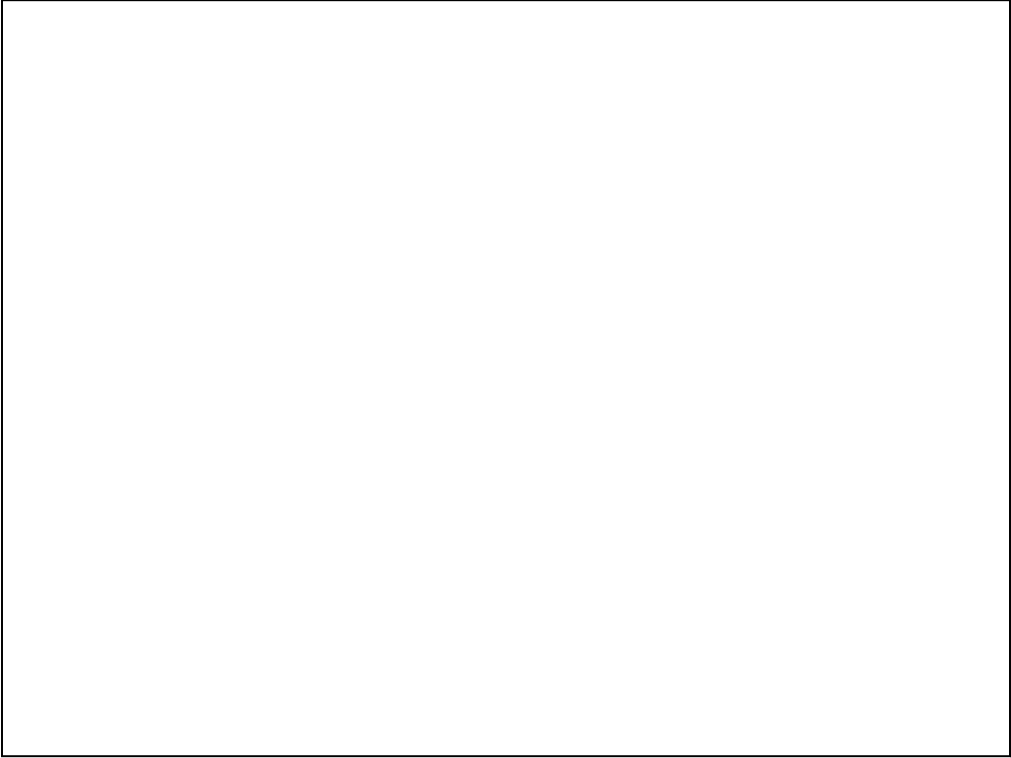

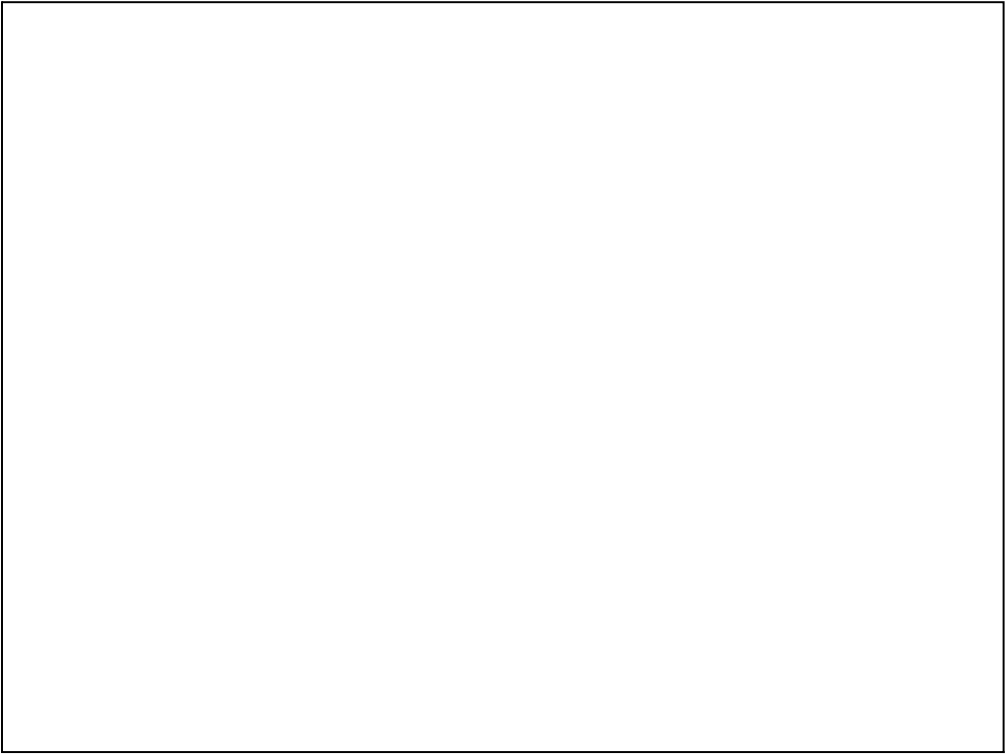



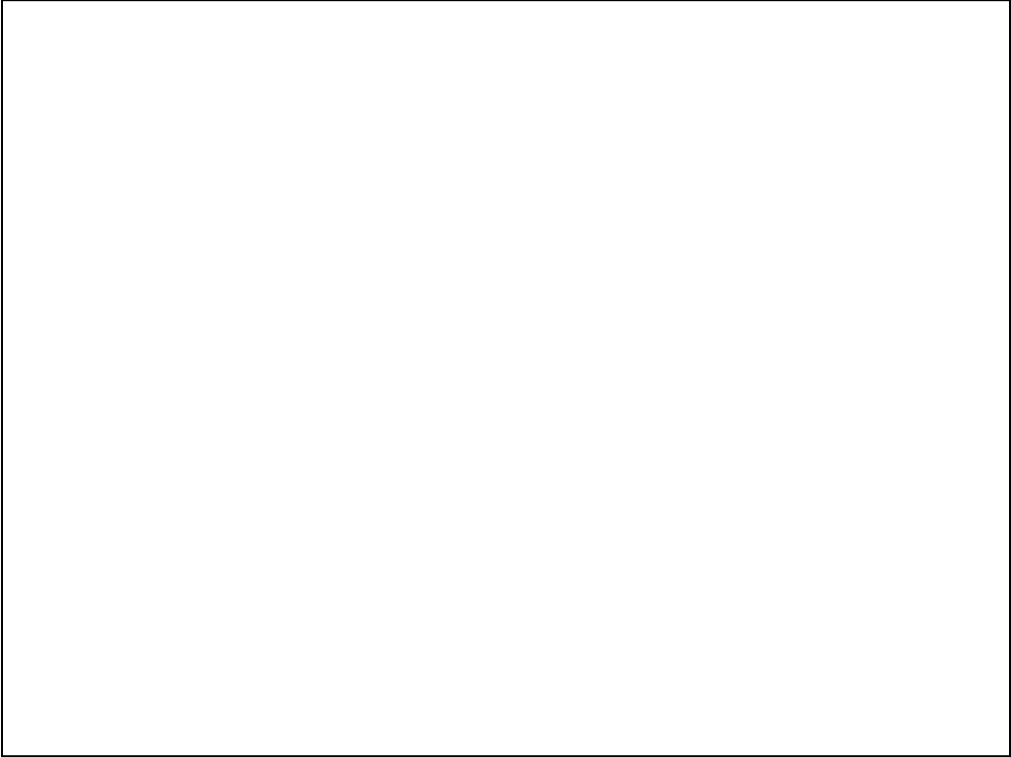

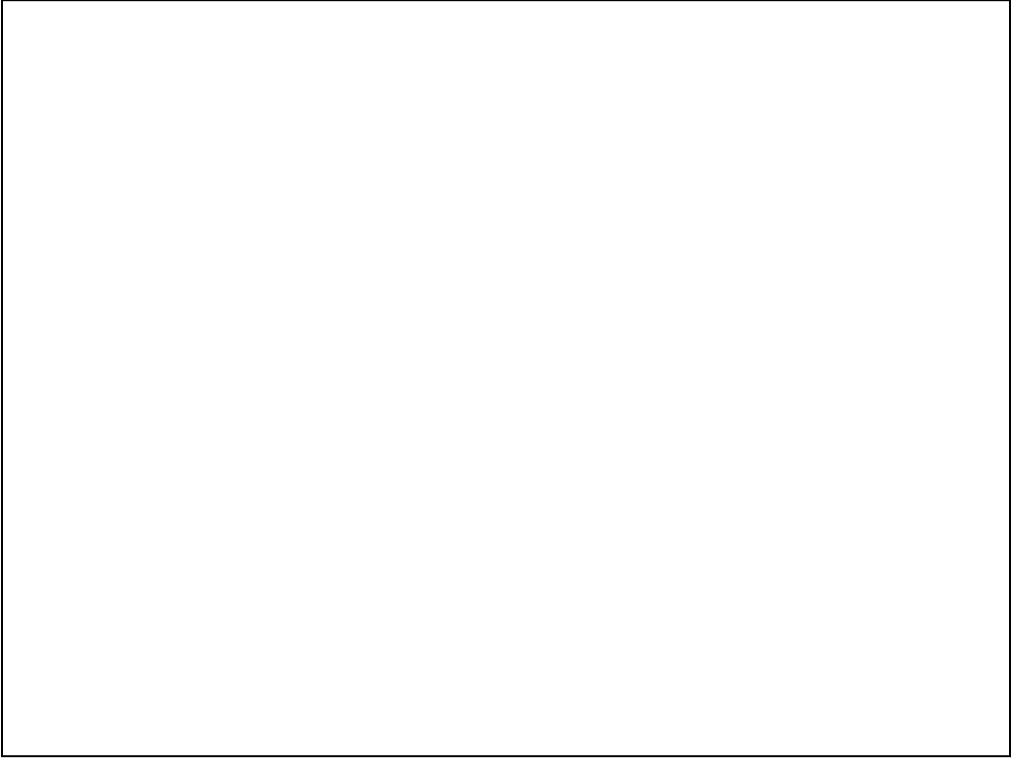

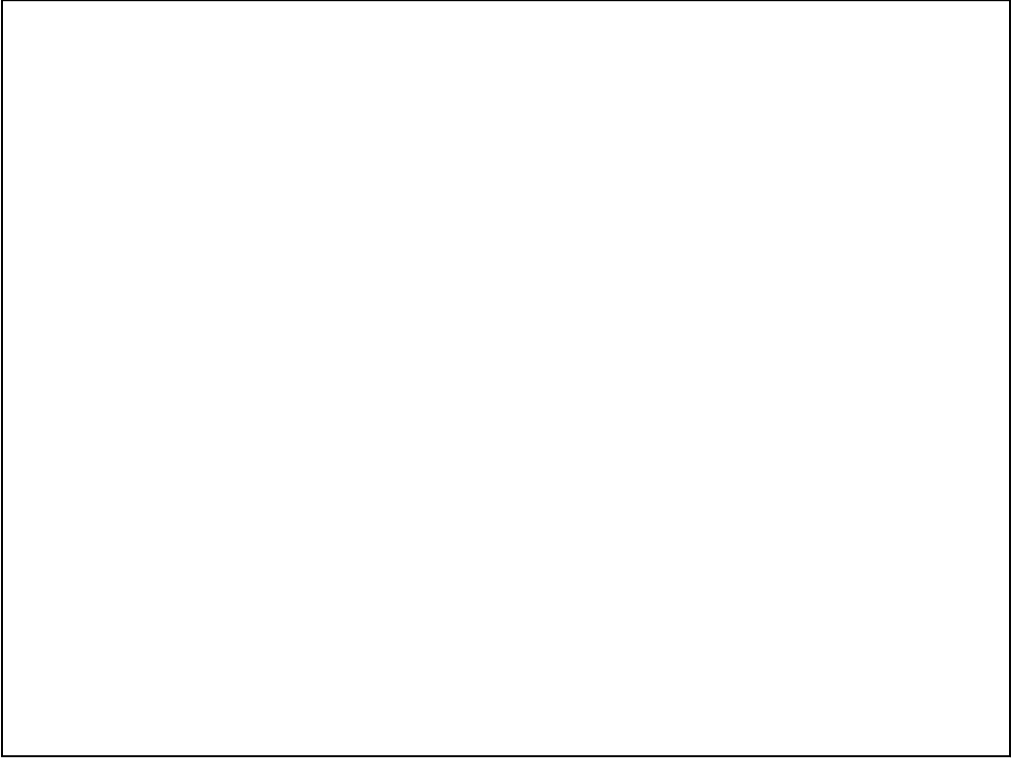



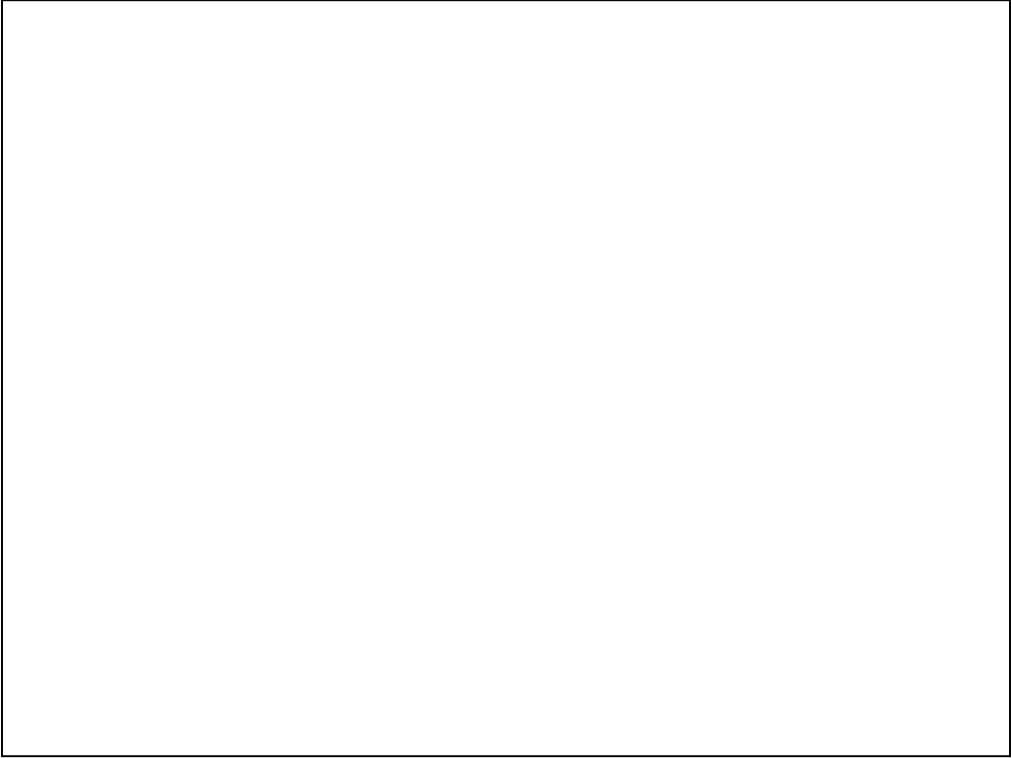

Multiplexing/demultiplexing

Demultiplexing at rcv host:

Delivering received segments to correct socket

Multiplexing at send host:

Gathering data from multiple sockets, enveloping data with header (later used for demultiplexing)

■ = socket ○ = process

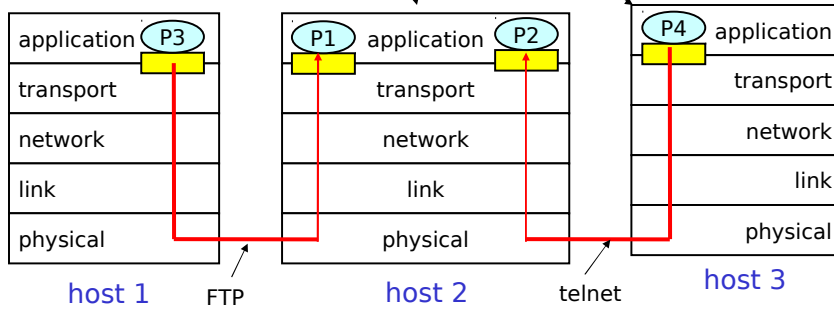

How Demultiplexing Works

Host Receives IP Datagrams

- Each Datagram has source IP Address, Destination IP Address
- Each Datagram carries 1 transport layer segment
- Each Segment has source/destination port number

Host Uses IP Addresses and Port numbers ----> direct segments to appropriate socket

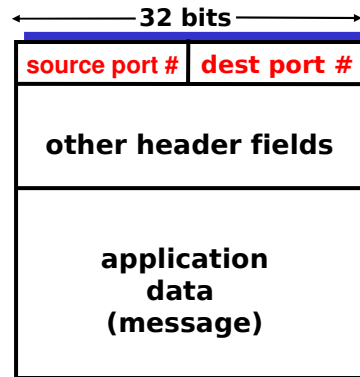

**Generic
TCP/UDP segment format**

